

KFX-BP

底板

订制品 



| |
|----------|
| 本体 |
| SCM415 |
| HRC58~60 |
| 四氧化三铁膜 |

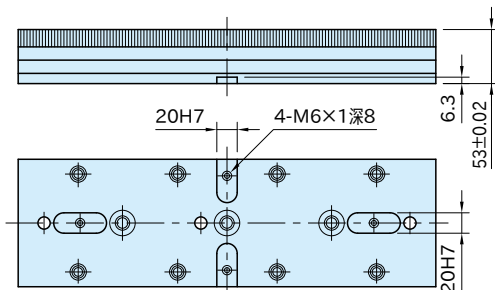
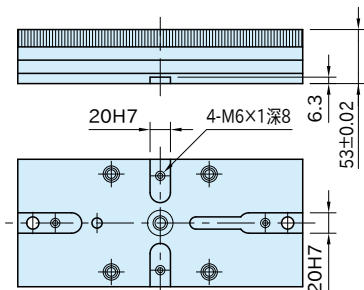
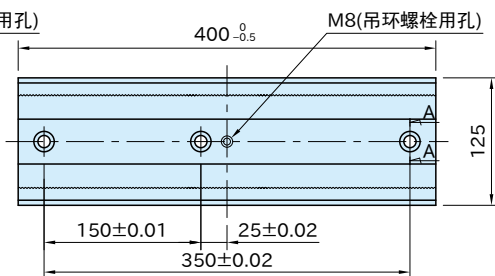
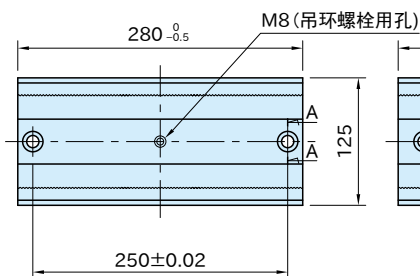

KFX-BP280

KFX-BP400

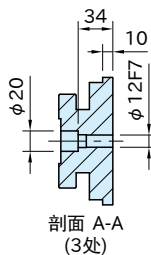
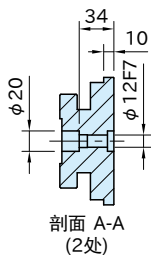

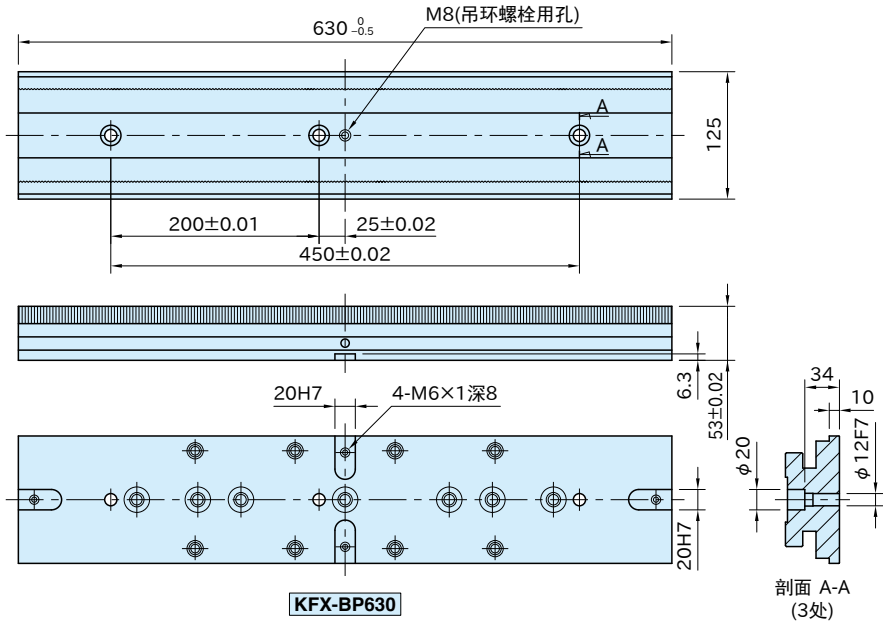

| 型 号 | 质量 (kg) |
|-----------|------------|
| KFX-BP280 | 10.8 |
| KFX-BP400 | 15.4 |
| KFX-BP630 | 24.6 |

特 点

- 通过交换底板也能够应对长形工件。
- 通过组合多个底板，也可以用在大型机床工作台上。

注 意 事 项

本产品为订货生产。货期请另行咨询本公司。

使用示例及使用方法

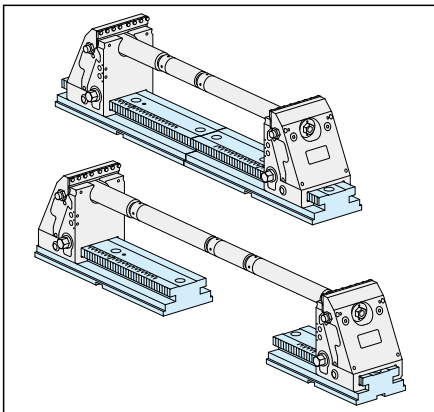

以刻度的标记为参考，可以用于配置 **KFX-CU** 夹紧组件。(参照P. KFX-CU)